



SIGMA

SHEETMETAL PRODUCTS LTD

WHOLESALE
PRODUCT
CATALOGUE

Eden



triumph

BUILDING PRODUCTS
APRIL 2008



Product Index

ITEM	PAGE NO
.55 flashings - (E2 AS1 Acceptable Solutions) - Flat Lead Edge, Lead Edge Angle, Plain Angle, Window Head, Horizontal Z	1
.55 flashings - (E2 AS1 Acceptable Solutions) - Corner Mould External / Internal, Sill Flashings, Internal / External Corners, Flat Cover Batten	2
.55 flashings - (E2 AS1 Acceptable Solutions) - Barge, Valley, Ridging, Saddle Flashings, Parapet Capping and Saddles, Cavity Base Closure	3
.55 Weatherboard Soakers - Standard, Hutlock and Cedar Soaker Nails - Galvanised, Stainless Steel and Silicone bronze	4
Louvre Vents (E2 AS1 Acceptable Solutions) - J Mould, Beam Capping, Pre-made Beam Caps, Sill Trays, Rainwater Products	5
Galvanised Rubbish Bins - 40 & 60 Litre Stainless Steel 50 litre Incinerator Eden Seafood Smokers - 1 & 2 Tray	6
Eden Letterboxes Letterbox Mounting Poles	7
*All flashings are 2.4m length unless specified.	
*Other lengths are available upon request.	



Sheetmetal Products Ltd
24 Princes St, Onehunga, Auckland
Ph: 09 636 3657
Fax: 09 636 3658
Web: www.sigmasheet.co.nz
email: sales@sigmasheet.co.nz

We can manufacture any profile required in most materials including Galvanised, Zinalume, Stainless Steel, Aluminium, Copper.
Contact us with your enquiry.

'NEW PROFILE' GALVANISED FLASHINGS

(E2AS1 ACCEPTABLE FLASHING SOLUTIONS)

All Lengths are 2400mm x 0.55mm unless specified

DESCRIPTION

GALVANISED

STAINLESS STEEL

COPPER

Price

Part No

Price

Price

Pack Size

FLAT LEAD EDGE

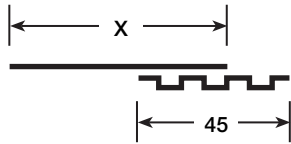

150mm
200mm
250mm
300mm

40302	P.O.A	P.O.A	5
40312	P.O.A	P.O.A	5
40332	P.O.A	P.O.A	5
40342	P.O.A	P.O.A	5

LEAD EDGED ANGLE

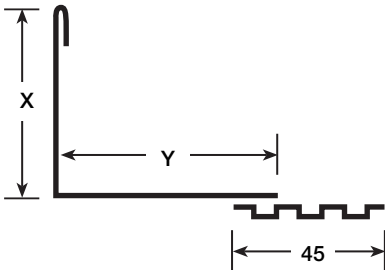

75 x 100mm
75 x 150mm
100 x 100mm
100 x 150mm
150 x 150mm

40406	P.O.A	P.O.A	5
40408	P.O.A	P.O.A	5
40412	P.O.A	P.O.A	5
40422	P.O.A	P.O.A	5
40432	P.O.A	P.O.A	5

PLAIN ANGLE

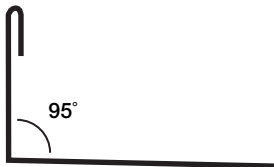

NO HEM PLAIN ANGLE

50 x 50
50 x 150
75 x 75
75 x 100
75 x 150
100 x 100
100 x 150
150 x 150
50 x 50

40511	P.O.A	P.O.A	25
40512	P.O.A	P.O.A	5
40522	P.O.A	P.O.A	5
40532	P.O.A	P.O.A	5
40542	P.O.A	P.O.A	5
40552	P.O.A	P.O.A	5
40562	P.O.A	P.O.A	5
40572	P.O.A	P.O.A	5
40510			

WINDOW HEAD FLASHING

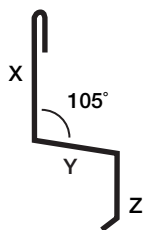

X Y Z
75 x 30 x 25
75 x 50 x 25
100 x 25 x 25
100 x 40 x 25
100 x 50 x 25
125 x 50 x 25
150 x 25 x 25
150 x 30 x 25
150 x 40 x 25
150 x 50 x 25
100 x 25 x 10

41112	P.O.A	P.O.A	5
41132	P.O.A	P.O.A	5
41142	P.O.A	P.O.A	5
41152	P.O.A	P.O.A	5
41162	P.O.A	P.O.A	5
41172	P.O.A	P.O.A	5
41182	P.O.A	P.O.A	5
41192	P.O.A	P.O.A	5
41202	P.O.A	P.O.A	5
41212	P.O.A	P.O.A	5
41222	P.O.A	P.O.A	5

HORIZONTAL Z

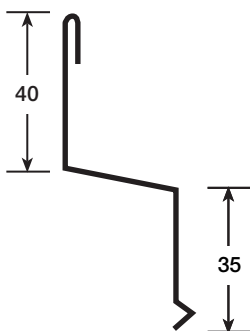

6mm
7.5mm
10mm
12mm
14mm
18mm

40132		P.O.A	25
40142		P.O.A	25
40152		P.O.A	25
40157		P.O.A	25
40162		P.O.A	25
40167		P.O.A	25

'NEW PROFILE' GALVANISED FLASHINGS (E2AS1 ACCEPTABLE FLASHING SOLUTIONS)

All Lengths are 2400mm x 0.55mm unless specified

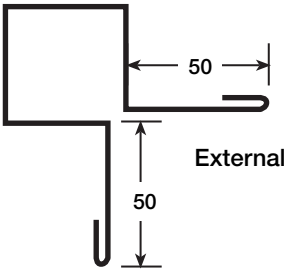
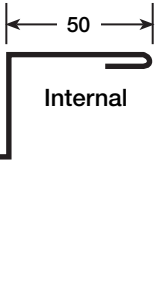
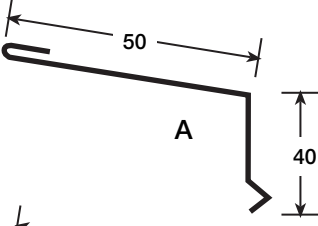
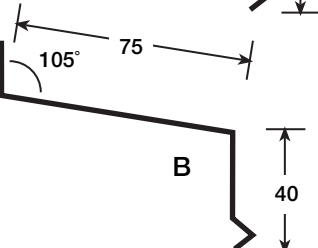
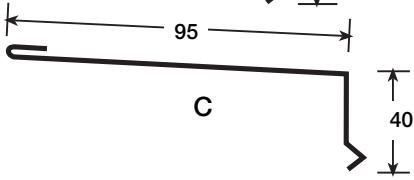
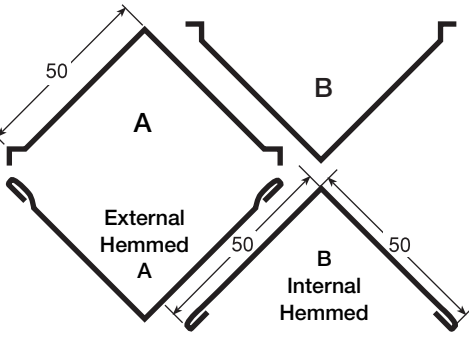
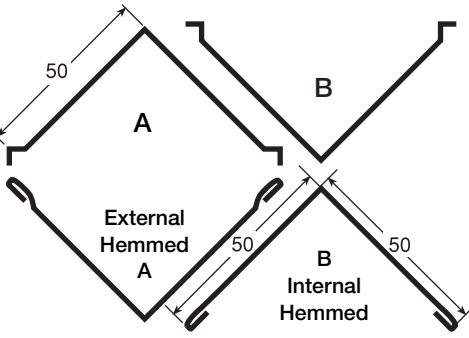
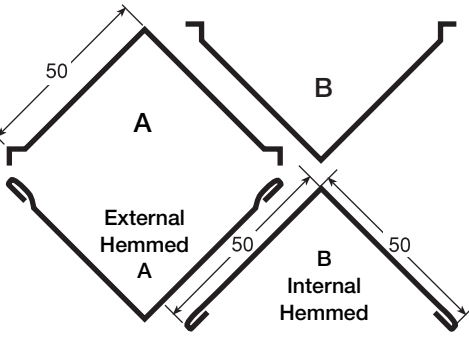
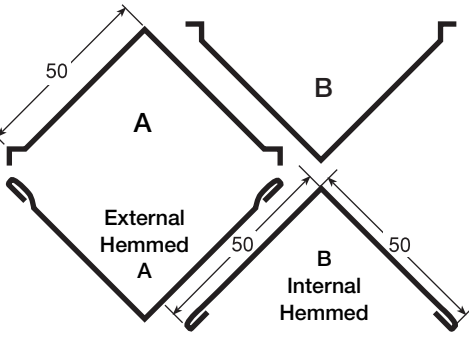
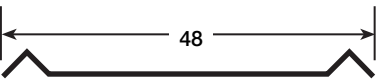
DESCRIPTION	GALVANISED		STAINLESS STEEL	COPPER	
	Price	Part No	Price	Price	Pack Size
 <p>External</p>		40180	P.O.A	P.O.A	1
 <p>Internal</p>		40170	P.O.A	P.O.A	1
SILL FLASHING					
 <p>A</p>		40910	P.O.A	P.O.A	1
 <p>B</p>		40915	P.O.A	P.O.A	1
 <p>C</p>		40920	P.O.A	P.O.A	1
 <p>External Corner (A)</p>		40102	P.O.A	P.O.A	25
 <p>External Hemmed (A)</p>		40105	P.O.A	P.O.A	25
 <p>Internal Corner (B)</p>		40112	P.O.A	P.O.A	25
 <p>Internal Hemmed (B)</p>		40115	P.O.A	P.O.A	25
 <p>Flat Cover Batten</p>		40122	P.O.A	P.O.A	25

'NEW PROFILE' GALVANISED FLASHINGS

(E2AS1 ACCEPTABLE FLASHING SOLUTIONS)

All Lengths are 2400mm x 0.55mm unless specified

DESCRIPTION

GALVANISED

STAINLESS STEEL

COPPER

Price

Part No

Price

Price

Pack Size

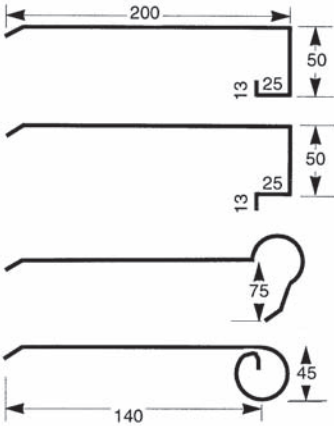

Square Barge T.U.

40022

P.O.A

P.O.A

5

Lead Edge Square Barge T.U.

40062

P.O.A

P.O.A

5

Square Barge T.D.

40012

P.O.A

P.O.A

5

Lead Edged Square Barge T.D.

40052

P.O.A

P.O.A

5

Round New Patt Barge

40032

P.O.A

P.O.A

5

Lead Edged Round New Patt Barge

40072

P.O.A

P.O.A

5

Round Old Patt Barge

40042

P.O.A

P.O.A

5

Lead Edged Round Old Patt Barge

40082

P.O.A

P.O.A

5

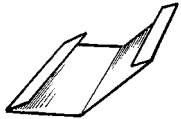

2400 x 0.55mm Galvanised Valley

40850

P.O.A

P.O.A

1

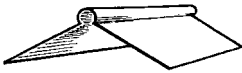

Plain Ridging .40 Galvanised

40700

P.O.A

P.O.A

1

Lead Edged Ridging .40 Galvanised

40730

P.O.A

P.O.A

1

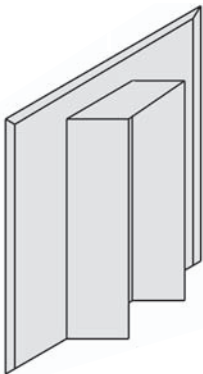

SADDLE FLASHING

P.O.A

P.O.A

P.O.A

1

Available in - Stainless Steel

- Galvanised

- Copper

- Aluminium

-Specify beam size & material required



PARAPET CAPPING & PARAPET SADDLES

P.O.A

P.O.A

P.O.A

1



CAVITY BASE CLOSURE

20mm

Also available - 35mm P.O.A

ALUMINIUM

STAINLESS STEEL

Price

Part No

Price

Part No

Pack Size

40220

40222

1

WEATHERBOARD (E2AS1 ACCEPTABLE) SOAKERS SOLUTIONS





DESCRIPTION	PACK SIZE	Galvanised		Copper		Stainless Steel	
		PRICE PER BOX (100)	PART No.	PRICE PER BOX (100)	PART No.	PRICE PER BOX (100)	PART No.
STANDARD BEVEL BACK WEATHERBOARDS							
<p>Soakers for Standard bevel back weatherboards</p>	Corner	150mm	100		42000	42110	42620
		200mm	100		42010	42120	42622
		225mm	100		42020	42130	
		250mm	100		42030	42140	
		300mm	100		42040	42150	
	135 Degree	150mm	100		42005	42115	42626
		200mm	100		42015	42125	42628
		225mm	100		42025		
	Flat	150mm	100		42060	42170	42632
		200mm	100		42070	42180	42634
		225mm	100		42080	42190	
		250mm	100		42090	42200	
		300mm	100		42100	42210	
Government Corner	150mm	100		42050			
REBATED BEVEL BACK WEATHERBOARDS (HUTLOCK)							
<p>Soakers for rebated bevel back weatherboards</p>	Corner	150mm	100		42220	42320	42644
		200mm	100		42230	42330	42646
		225mm	100		42240	42340	
		250mm	100		42250		
		300mm	100		42260		
	135 Degree	150mm	100		42225	42325	42650
		200mm	100		42235	42335	42652
	Flat	150mm	100		42270	42350	42656
		200mm	100		42280	42360	42658
		225mm	100		42290	42370	
		250mm	100		42300		
		300mm	100		42310		
	SPLAY CUT WEATHERBOARDS (CEDAR)						
<p>Soakers for splay cut weatherboards</p>	Corner	150mm	100		42380	42480	42668
		200mm	100		42390	42490	42670
		225mm	100		42400	42500	
		250mm	100		42410	42510	
		300mm	100		42420		
	135 Degree	150mm	100		42385	42485	42674
		200mm	100		42395	42495	42676
	Flat	150mm	100		42430	42520	42680
		200mm	100		42440	42530	42682
		225mm	100		42450	42540	
		250mm	100		42460	42550	
		300mm	100		42470		
	SOAKER NAILS (packed in jars)						
16g x 3/4 inch Silicone Bronze Nails	200 per jar		42560				
16g x 3/4 inch Galvanised Nails	500 per jar		42570				
1.6 x 19mm Stainless Steel Nails	270 per jar		42561				

All prices are exclusive of G.S.T.

GALVANISED LOUVRE VENTS (E2AS1 ACCEPTABLE SOLUTIONS)

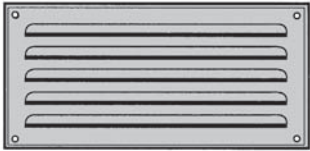
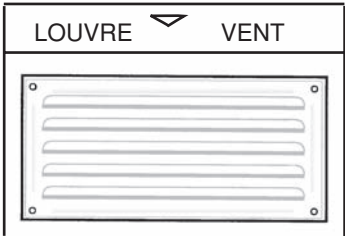
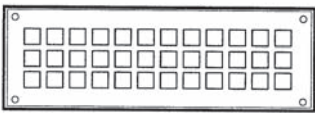

DESCRIPTION	PRICE PER LENGTH	PART No.	PACK SIZE
GALVANISED LOUVRE VENT			
 Louvre Vent 300 x 100mm		41010	25
Louvre Vent 300 x 150mm		41020	25
Louvre Vent 300 x 200mm		41030	25
Louvre Vent 200 x 250mm		41040	25
Louvre Vent 450 x 240mm Heavy Gauge .95mm		41045	1
WHITE PAINTED LOUVRE VENT			
 Louvre Vent 300 x 100mm		41080	1
Louvre Vent 300 x 150mm		41082	1
Louvre Vent 300 x 200mm		41086	1
Louvre Vent 450 x 240mm		41088	1
 Square Hole Vents 300 x 100mm		41060	25
Square Hole Vents 228 x 166mm		41050	25
 'J' Mould 50 x 9.5mm		40250	25
Beam Capping 47 x 10 x 2400mm		40190	1
94 x 10 x 2400mm		40200	1
Pre-made Beam Caps 94 x 10 x 150mm		43550	1
94 x 10 x 200mm		43560	1
Sill Trays 140 x 10mm		40900	25

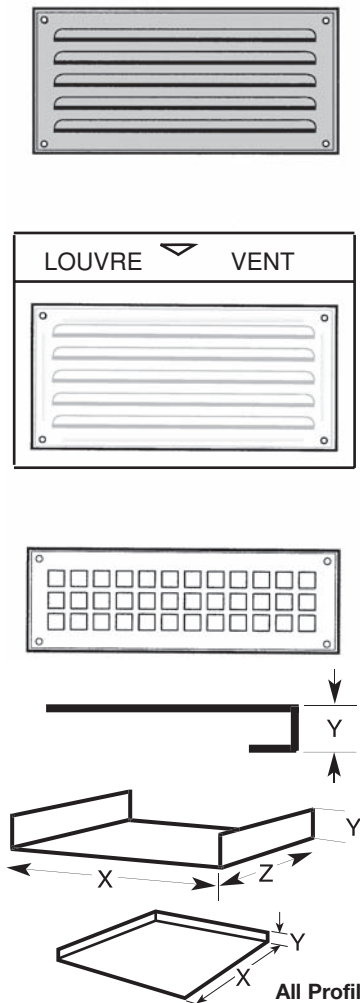

All Profiles can be supplied in either Copper, Stainless Steel or Aluminium. Prices on application.

DESCRIPTION	GALVANISED		COPPER		Also available in Stainless Steel
	PRICE PER LENGTH	PART No.	PRICE PER LENGTH	PART No.	PACK SIZE
RAINWATER PRODUCTS					
Downpipe 65mm	—	—		43395	25
2400mm lengths		43100		43400	25
75mm		43110		43410	1
100mm		43120	—	—	1
125mm		43130	—	—	1
150mm					
Dropper 65mm		—		43445	1
75mm		43150		43450	1
100mm		43155		43455	
125mm		43160	—	—	1
150mm		43165	—	—	1
Stand Off Brackets 75mm		43180		43480	1
100mm		43185		43485	1
125mm		43190	—	—	1
150mm		43195	—	—	1

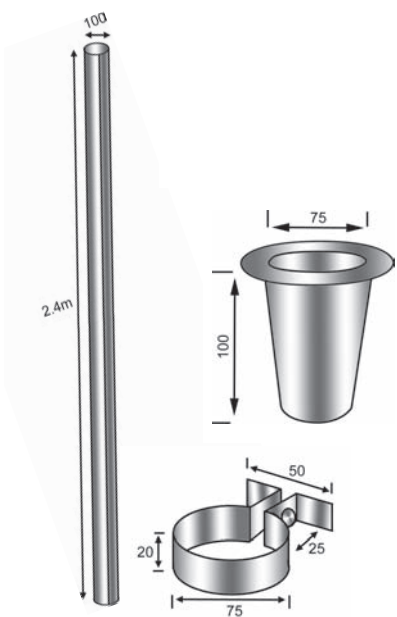

'EDEN' RUBBISH BINS, INCINERATORS, SEAFOOD SMOKER



DESCRIPTION	PRICE PER UNIT	PART No.	PACK SIZE
GALVANISED RUBBISH BINS			
60 litres 590 H x 400 D		50710	1
40 litres 420 H x 400 D		50700	1
Spare Bin			
60 litres		50711	1
40 litres		50701	1
Spare Lid			
60 litres and 40 litres		50702	1
Bin Liners			
60 litres		50715	1
STAINLESS STEEL RUBBISH BIN			
60 litres 590 H x 400 D			1
STAINLESS STEEL INCINERATOR			
50 litres		50200	1
Spare Body		50220	1
Spare Lid		50210	1
Spare Base		50230	1

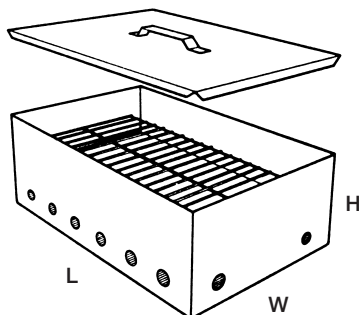
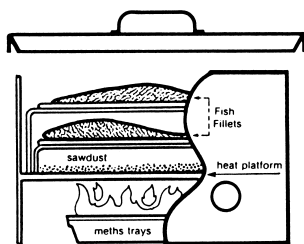
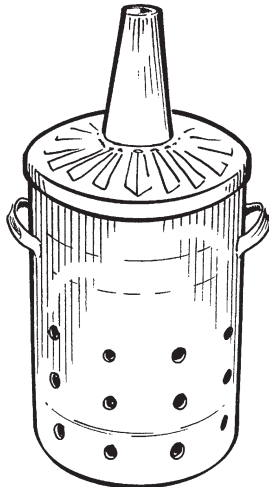
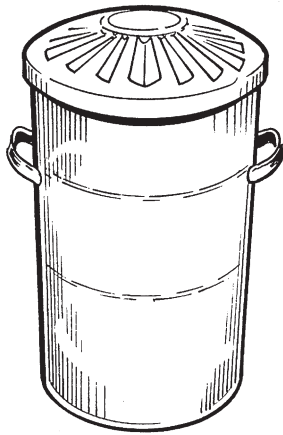

DESCRIPTION	PRICE PER UNIT	PART No.	PACK SIZE
EDEN SEAFOOD SMOKER STAINLESS STEEL			
315 W x 440 L x 160 H			
1 Tray		50320	1
2 Tray		50325	1

All prices are exclusive of G.S.T.

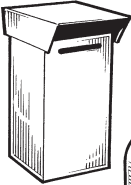
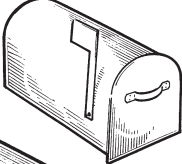
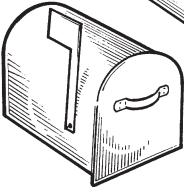
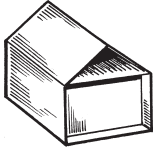
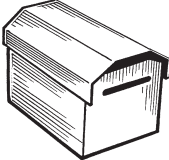
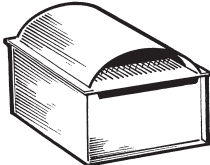
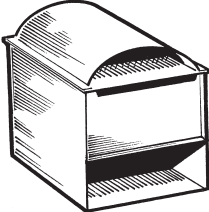
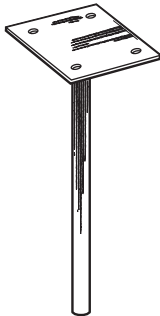

'EDEN' LETTERBOXES

	DESCRIPTION	OPENING	COLOUR	UNIT PRICE exc. GST	PART No.
	203 Flat Top 350L x 225W x 460mmH	Rear	White		50945
	231 Rural Small	Front	Galv		50908
	231 Rural Small 500L x 195W x 225mmH	Front	Green		50928
	233 Rural Large	Front	Galv		50910
	233 Rural Large 400L x 290W x 310mmH	Front	Green		50930
	312 Compact Gable 345L x 235W x 230mmH	Rear	White		51000
	313 Fliptop	Top	White/Green		51005
	313 Fliptop	Top	White		51015
	313 Fliptop 400L x 235W x 250mmH	Top	Green		51010
	620 A4 340L x 300W x 205mmH	Front	Off White		51050
	650 A4 340L x 300W x 325mmH	Front	Off White		51070
	BOTTOM MOUNTING LETTERBOX POLE				51100
	SIDE MOUNTING LETTERBOX POLE				51105
	BOTTOM MOUNTING LETTERBOX POLE - 50mm Diameter				51114
	STAINLESS STEEL BOTTOM MOUNTING LETTERBOX POLE - 50mm Diameter				51112

* Special Colours Available Upon Request

All prices are exclusive of G.S.T.

PROUDLY 100%



NZ OWNED AND OPERATED



Phone: 0-9-636 3657 • Fax: 0-9-636 3658

24 Princes St, Onehunga, Auckland, New Zealand • PO Box 13-013, Auckland
email: sigmasheet@xtra.co.nz • web: www.sigmasheet.co.nz